



**SURE**  
PETCARE



surepetcare.com



0800 912 7114



**SURE FLAP**<sup>®</sup>

microchip pet doors

# Introduction



“ I want our products to look great, be the best at what they do and be loved by the people who buy them.”

Nick Hill – Founder

Sure Petcare was started by Cambridge physicist Dr Nick Hill in his spare bedroom, to solve the problem of unwanted neighbourhood cats getting into his house. Our first product, the Microchip Cat Flap, was launched in 2008.

We are now a dedicated team of people operating all over the world committed to delivering the best products supported by the best service.

We solve problems with great design and clever thinking.

When a pet owner buys a Sure Petcare product it quickly becomes an essential part of their animal’s care. This means we don’t settle for delivering anything less than the best and most reliable products.

Whether you are an existing trade partner or are considering stocking Sure Petcare products for the first time, we want you to have the confidence that we are here to support your customers.



Meet Nick



Our pet doors have won European pet industry awards for design and innovation.

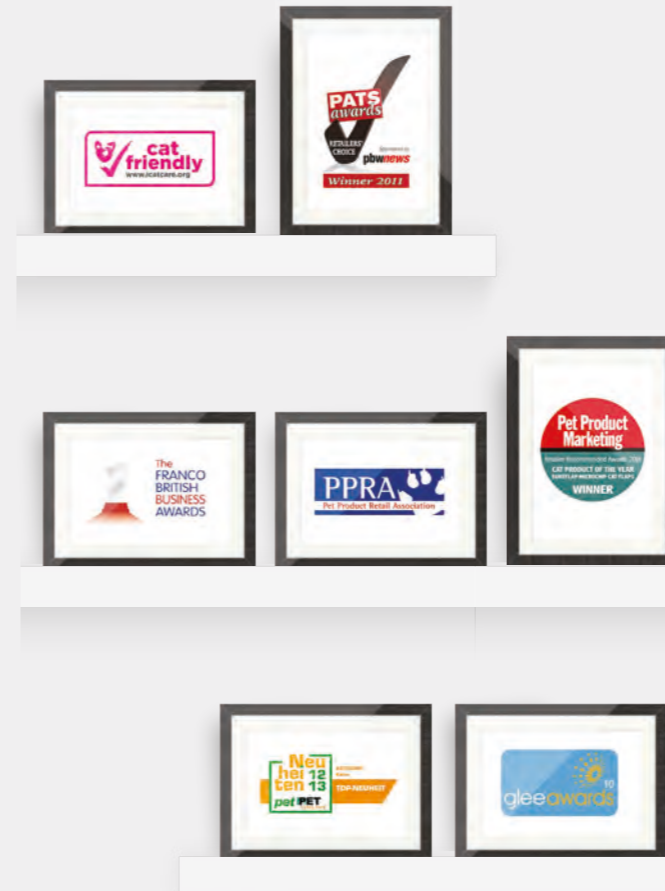

# Contents

- Why a microchip pet door? ..... 4
- How do SureFlap doors work? ..... 5
- Help your customer to choose the right door... 6
- Product comparison chart ..... 7
- Microchip Cat Flap ..... 8 - 9
- DualScan™ Microchip Cat Flap.....10 - 11
- Microchip Pet Door .....12 - 13
- Installation accessories.....14 - 15
- FAQs .....17 - 18
- Detailed product information .....20 - 21
- How to order .....22
- Customer service & warranties ..... 23

# Why a microchip pet door?

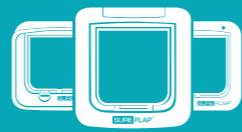

# How do SureFlap doors work?



**51%** of cat owners with non-selective cat flaps experienced intruder cats in their home.

**39%** of cat owners with non-selective cat flaps have experienced an intruder cat coming into the home and stealing food.

**25%** of cats living in these households have been attacked in their home by an intruder cat.



Injuries from cat fights are 2.5 times more likely to occur than road traffic accidents.

**Pets who have been in fights are more prone to stress-related illnesses and have more frequent visits to the vets to resolve these problems.**

*Neighbourhood Cat Campaign 2013. SureFlap and Your Cat Magazine.*

SureFlap pet doors **stop intruder animals** entering the home by recognising the existing identification microchip of the resident pet and **unlocking only for them.**



WHY A SUREFLAP?	SUREFLAP DOORS	MAGNETIC DOORS	NON-SELECTIVE DOORS
Access control	Only let your pet(s) into your home	Let any animal with a magnetic collar tag into your home	Let any animal into your home
What does your pet need to make it work?	Pet(s) should be microchipped Non-microchipped pets can wear a safety collar and a Sure Petcare RFID collar tag	Pet(s) must wear a collar and tag	-
Does it provide a safe environment?	Yes	Only if your neighbours do not have the same type of pet door	No
Ongoing cost of ownership	New batteries every year	Collar & key replacement (required frequently for some cats)	Extra food, damaged furnishings etc.

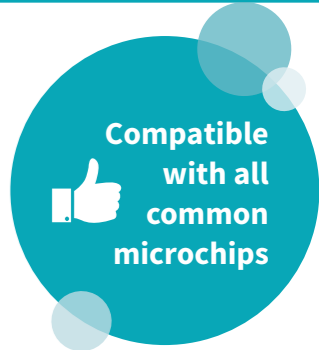

1

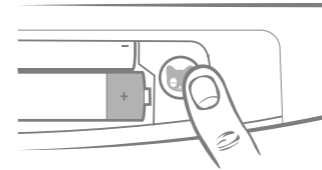

**Program the cat flap with one press of a button.**

The resident cat's unique microchip ID is then permanently stored in the cat flap's memory.

2

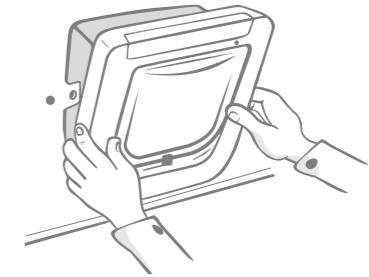

**Install the cat flap in a door, window or wall.**

Accessories are available for window and wall installations.

3

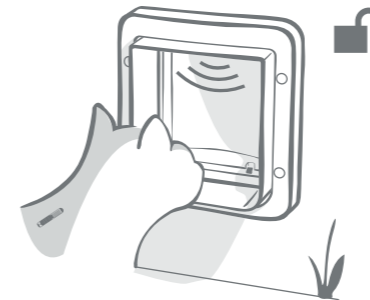

**The cat flap unlocks when the resident pet approaches.**

It reads the unique code on a pet's existing microchip or collar tag.

4

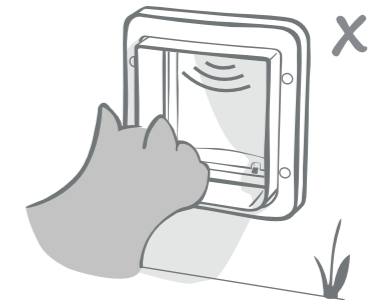

**Intruder animals can't get in.**

The cat flap remains locked for unwelcome cats and wildlife.

# Help your customer to choose the right door

# Product comparison chart

## Establish your customer's needs

Understanding your customer and their pets' needs will enable you to assist them in choosing the best SureFlap product for their home. Here are some questions you should use to engage with them:

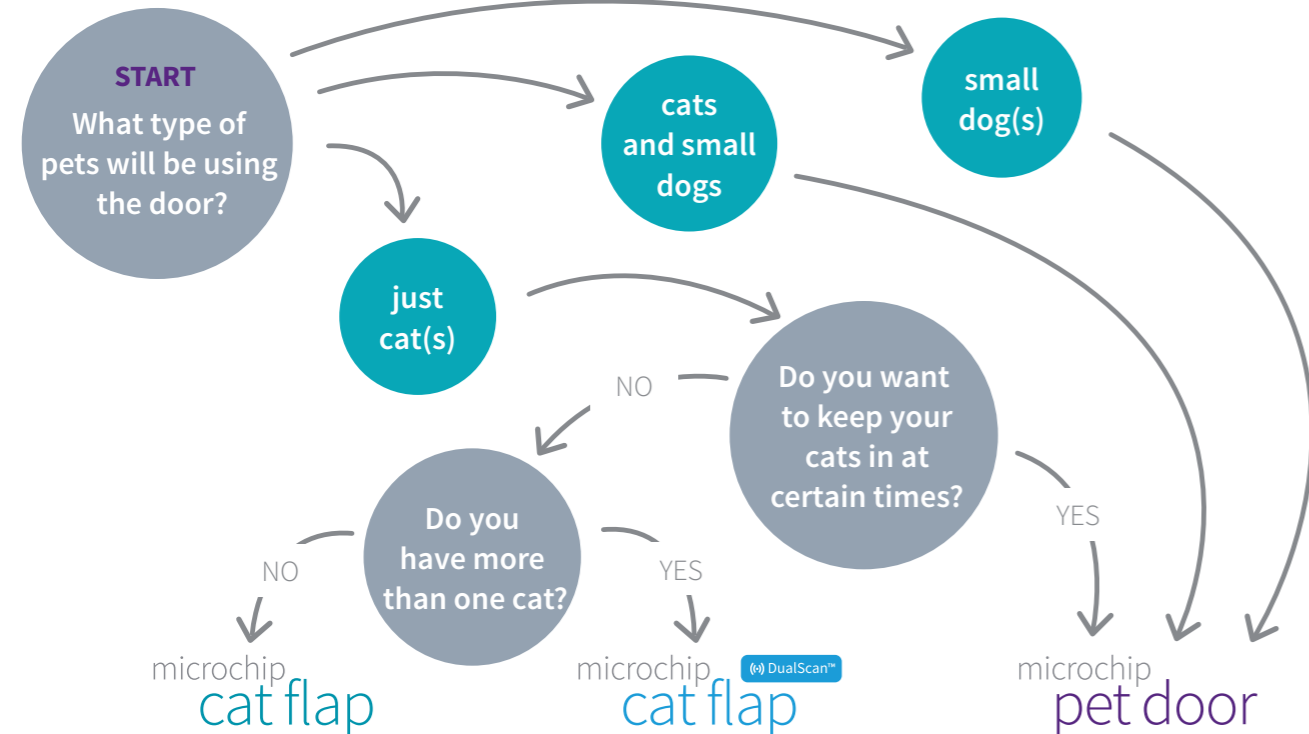
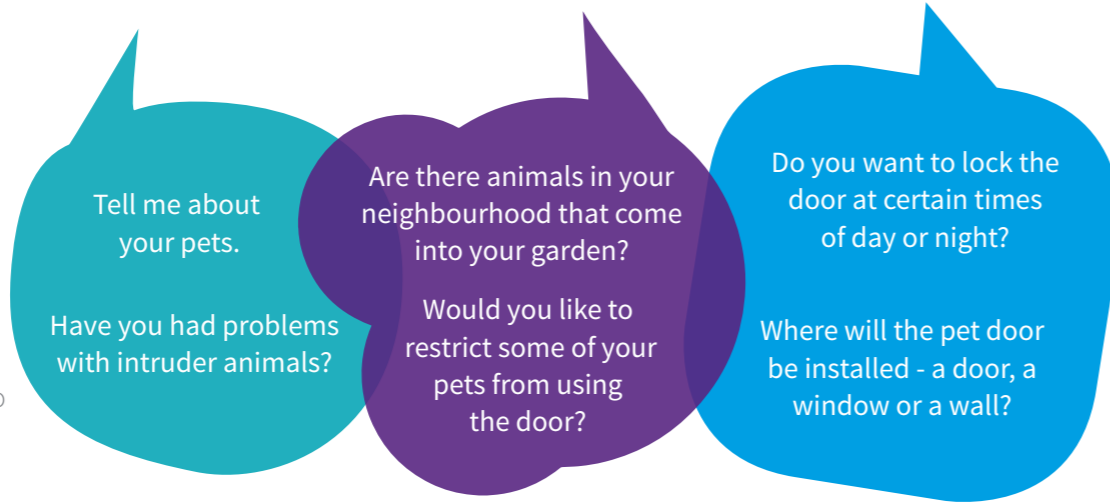

	microchip cat flap	microchip DualScan cat flap	microchip pet door
Compatible with all common microchips	✓	✓	✓
Compatible with RFID collar tag	✓	✓	✓
Scans on entry	✓	✓	✓
Scans on exit	✗	✓	✗
Curfew timer control	✗	✗	✓
Manual lock	✓	✓	✓
Batteries required	4 x AA (not included)	4 x AA (not included)	4 x C Cell (not included)
Flap opening W x H (mm)	142 x 120	142 x 120	178 x 170
Door/wall - hole size W x H (mm)	166 x 172	166 x 172	207 x 234
Glass - hole diameter (mm)	210 - 260	210 - 260	294 - 320

# microchip cat flap

PRODUCT CODE: **SUR001**  
**SUR001BR**



## IDEAL FOR SINGLE CAT HOUSEHOLDS

Territory invasion or perceived threat to their home from another animal is a major cause of stress in cats. Installing a secure pet door can reduce this. The microchip reader only scans the microchip on the way into the house. If a customer has multiple cats and some need to be kept indoors the **DualScan™ Microchip Cat Flap** is an ideal option (see page 10).

If the customer would like to keep their pets in overnight they might consider the **SureFlap Microchip Pet Door**, which has an electronic lock timer (page 12).

## WHAT'S IN THE BOX?

- ① Cat flap
- ② External frame
- ③ 2 x screw caps
- ④ 2 x 30 mm screws
- ⑤ 2 x 50 mm screws
- ⑥ 2 x 75 mm screws

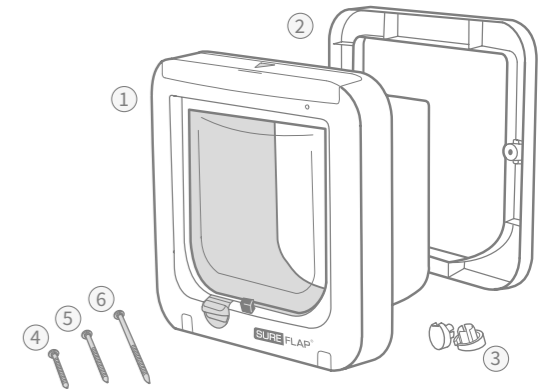

## PRODUCT FEATURES



Prevents intruder animals entering the home

**32**

Stores up to 32 pet identities in memory



Can be installed into doors, windows and walls



Selective entry – any animal can exit. Microchip reader is located on the outside of the cat flap only



Compatible with all common identification microchips & Sure Petcare RFID collar tags (not included)



Manual lock stops cats leaving or entering the house



Battery life - 12 months (4xAA batteries – not included)



Simple one-button programming



Low battery indicator light

## PRODUCT SPECIFICATIONS

### Flap opening

142mm (W) x 120mm (H)

### Tunnel depth

70mm

### Hole dimensions

165mm (W) x 171mm (H)

### Batteries

4 x AA (not included)

### Exterior frame dimensions

210mm (W) x 210mm (H)

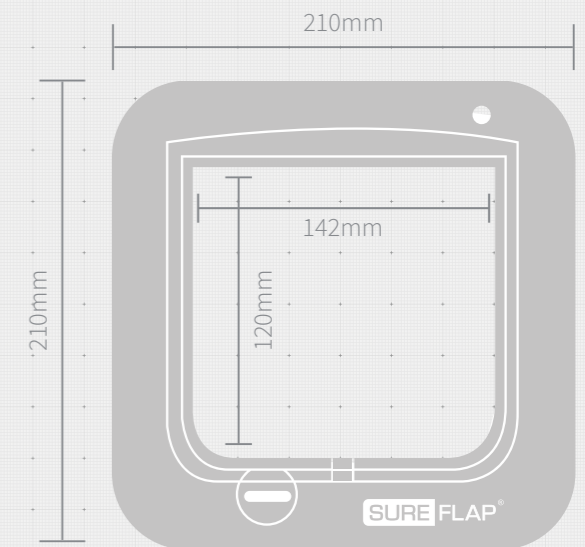



### IDEAL FOR HOUSEHOLDS WITH MULTIPLE CATS

The DualScan Microchip Cat Flap has a microchip reader on the inside, as well as the outside. Using DualScan technology, owners are able to set exit permissions for each pet to keep specific pets indoors, making it ideal for households with more than one cat.

### WHAT'S IN THE BOX?

- ① DualScan Cat Flap
- ② External frame
- ③ 2 x screw caps
- ④ 2 x 30 mm screws
- ⑤ 2 x 50 mm screws
- ⑥ 2 x 75 mm screws

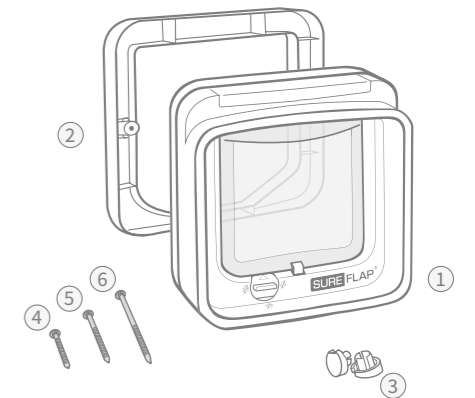

### PRODUCT SPECIFICATIONS

- Flap opening  
142mm (W) x 120mm (H)
- Hole dimensions  
165mm (W) x 171mm (H)
- Exterior frame dimensions  
210mm (W) x 210mm (H)
- Tunnel depth  
70mm
- Batteries  
4 x AA (not included)

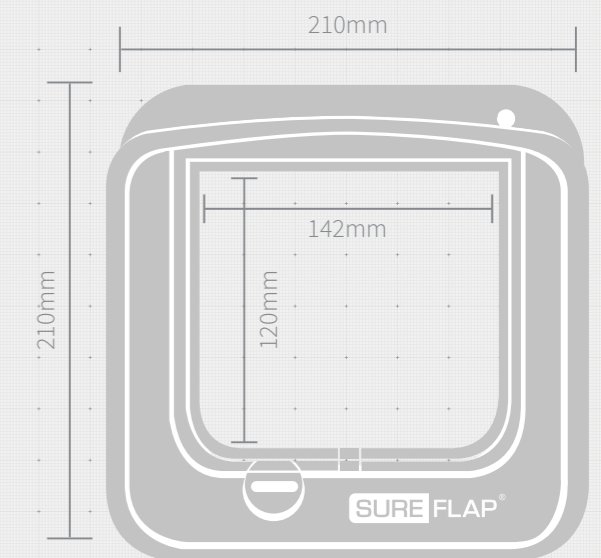

### PRODUCT FEATURES

- DualScan™ Technology - set exit permissions for each pet, keep specific pets indoors
- Compatible with all common identification microchips & RFID collar tags (not included)
- Battery life - 12 months (4xAA batteries – not included)
- Safety mode - Indoor-only pets can gain entry if they escape
- Simple one-button programming – change permissions at any time
- Low battery indicator light
- Prevents intruder animals entering the home
- Manual lock to stop pets leaving or entering the house
- Can be installed into doors, windows and walls

# microchip pet door

PRODUCT CODE: **SUR101**  
**SUR101BR**



## IDEAL FOR LARGE CATS AND SMALL DOGS

The SureFlap Microchip Pet Door offers convenience and control for the owner. Any pet can leave the house, but the Curfew Mode allows owners to control at which times of day. The door's larger size makes it ideal for bigger breeds of cat and small dogs.

## WHAT'S IN THE BOX?

- ① Pet door
- ② External frame
- ③ 2 x screw caps
- ④ 2 x 30 mm screws
- ⑤ 2 x 50 mm screws
- ⑥ 2 x 75 mm screws
- ⑦ 1 x collar tag

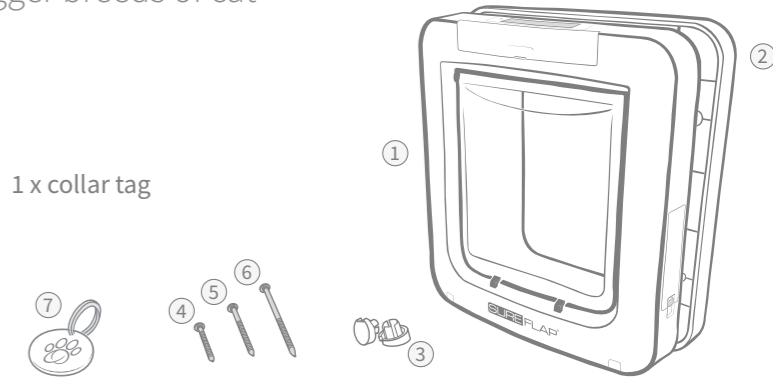

## PRODUCT SPECIFICATIONS

Flap opening 178mm (W) x 170mm (H)	Tunnel depth 70mm
Hole dimensions 207mm (W) x 234mm (H)	Batteries 4 x C (not included)
Exterior frame dimensions 262mm (W) x 281mm (H)	

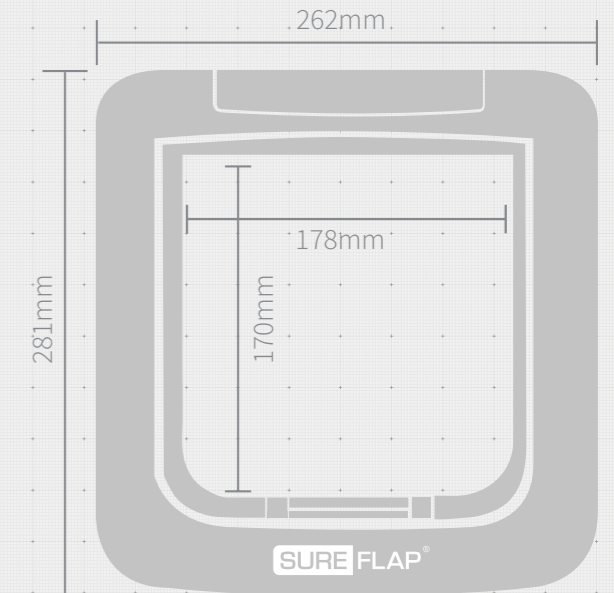

## PRODUCT FEATURES

- Designed for large cats and small dogs
- Compatible with all identification microchips worldwide & Sure Petcare RFID collar tags
- Battery life - 12 months (4x C cell batteries – not included)
- Curfew mode - program the door to lock and unlock at specified times
- Includes 1 RFID collar tag (additional tags sold separately)
- LCD display with low battery indicator
- Prevents intruder animals entering the home
- Selective entry – any animal can exit
- Can be installed into doors, windows and walls



## All SureFlap pet doors can be installed in doors, glass or walls.



### Door installations

The simple two-part construction makes SureFlap products quick and easy to install. A mounting adaptor may be required depending on the type of door.



### Wall installations

Tunnel extenders are available to install products into a wall of any depth. A mounting adaptor may be required for the Microchip Cat Flap and DualScan™ Microchip Cat Flap.



### Glass installations

Customers will need to contact a qualified glazier to help them with installation, as a circular hole is required. Mounting adaptors are essential.



**TUNNEL  
EXTENDER**



**MOUNTING  
ADAPTOR**

There are two installation accessories for each product in the pet door range. As the Microchip Cat Flap and DualScan Microchip Cat Flap are the same size, these accessories are common to both. Understanding whether your customer needs accessories and supplying them at the time of purchase will improve their buying experience.

	microchip cat flap	microchip <sup>DualScan™</sup> cat flap	microchip pet door
<b>Door installation</b>	✓	✓	✓
Door hole size W x H (mm)	166 x 172		166 x 172
<b>Window/glass installation</b>	✓	✓	✓
Glass - hole diameter (mm)	210 - 260		294 - 320
Recommended mounting accessory [white or brown (BR)]	Mounting Adaptor GMA001 / GMA001BR		Mounting Adaptor GMA101 / GMA101BR
<b>Wall installation</b>	✓	✓	✓
Wall hole size W x H (mm)	166 x 172		207 x 234
Recommended mounting accessories [white or brown (BR)]	Mounting Adaptor GMA001 / GMA001BR  Tunnel Extender TUN001 / TUN001BR		Tunnel Extender TUN101 / TUN101BR



## FAQs



### 1. Do SureFlap microchip pet doors work with my pet's existing microchip?

Yes. SureFlap microchip pet doors are compatible with all common microchip types.

- 15-digit microchips (also known as FDXB, standard in Europe)
- 10-digit microchips\* (also known as FDXA, most commonly used in the USA)
- 9-digit microchips (also known as Avid Secure/Encrypted Chip)

In order to ensure operation with your pet we do advise testing BEFORE installation.

(\*The SureFlap Microchip Cat Flap and DualScan Microchip Cat Flap are not compatible with microchip codes starting 000..., 010..., 020...)

### 2. How do SureFlap microchip pet doors know my pet's microchip number?

When SureFlap microchip pet doors are put into 'Add a pet' mode, the door unlocks. The pet door reads the microchip of the next animal to put its head into the tunnel and its unique ID number is permanently stored in the memory. That pet will now be recognised by the pet door.

Using this 'Add a pet' mode you don't have to force an uncooperative pet through the flap. Just leave the product in 'Add a pet' mode and let them go through in their own good time. In multi-pet households repeat the process for each pet.

### 3. Can another cat have the same microchip number and get in?

No. Each microchip has a unique ID number, so intruder animals have no chance of opening the pet door.

### 4. I have more than one pet. Can SureFlap microchip pet doors recognise all of them?

Yes, SureFlap microchip pet doors can recognise up to 32 different pet identities.

### 5. My pet isn't microchipped, can it use a SureFlap microchip pet door?

Yes, SureFlap products can also be used with a Sure Petcare RFID Collar Tag which should be attached to a safety collar. Each collar tag has a unique number like a microchip. *Note: Collar tags are not supplied with the SureFlap Microchip Cat Flap or the DualScan Microchip Cat Flap.*

### 6. How do I know when the batteries need changing?

The LED on the product will flash red every 4-5 seconds when the batteries need changing. The LED will flash for several days/weeks before the batteries run down and the door stops operating.

7. Are the microchip numbers stored when I change the batteries?

Yes, once a pet's microchip number is stored it stays in the memory even if the batteries are removed.

8. What kind of batteries do you recommend using with SureFlap pet doors?

The SureFlap Microchip Cat Flap and DualScan™ Microchip Cat Flap operate using 4 AA (1.5V) batteries. The SureFlap Microchip Pet Door operates using 4 C cell (1.5V) batteries.

We recommend the use of good quality, alkaline batteries in order to give the longest lifetime. We do not recommend the use of rechargeable batteries.

9. My pet wears a collar with a metallic bell/tag. Can it still use SureFlap pet doors?

Yes, pets wearing collars (metallic or not) can use SureFlap pet doors without any problems.

10. We have an invisible fence for our pets' protection. Will this interfere with the operation of SureFlap microchip pet doors and vice versa?

We have had a number of customers using SureFlap microchip pet doors in conjunction with an invisible fence with no problems reported.

11. How should I clean my SureFlap microchip pet door?

An optical sensor on the roof of the tunnel just behind the door detects the presence of a pet in the tunnel. If the two clear lenses become obscured by dirt or pet fur, unreliable operation and/or shortened battery life may result. Every couple of months wipe these lenses with a damp cloth and remove any fur that may be stuck to the draft excluder on the top of the door. Operation of the sensor relies on a reflection from the base of the tunnel, which should also be kept reasonably clean. After cleaning, leave your SureFlap pet door for approximately 10 seconds for the unit to settle.

*Note: On the DualScan Microchip Cat Flap there are sensors on both sides of the door that will need to be cleaned.*



# Detailed product information

PRODUCT INFORMATION				SINGLE PRODUCT DETAILS					MASTER CARTON INFORMATION					
PRODUCT NAME	COLOUR	PRODUCT CODE	RRP (£)	WIDTH (CM)	HEIGHT (CM)	LENGTH (CM)	WEIGHT (KG)	BARCODE (EAN)	WIDTH (CM)	HEIGHT (CM)	LENGTH (CM)	WEIGHT (KG)	PIECES	BARCODE (EAN)
Microchip Cat Flap	White	SUR001	79.99	22.0	25.0	13.0	1.3	5060180390006	67.5	45.5	29.2	14.4	10	05060180390228
	Brown	SUR001BR						5060180390112						05060180390259
DualScan Microchip Cat Flap	White	DSCF001	99.99	23.0	25.0	18.0	1.64	5060180390389	56	48	29	11.2	6	05060180390464
	Brown	DSCF001BR						5060180390396						05060180390471
Cat Flap Mounting Adaptor	White	GMA001	9.99	32.0	37.0	1.5	0.27	5060180390013	35	39	41	7.3	20	05060180390235
	Brown	GMA001BR						5060180390129						05060180390266
Cat Flap Tunnel Extender	White	TUN001	6.99	20.0	26.0	6.0	0.12	5060180390174	66	55	40	7.9	40	05060180390242
	Brown	TUN001BR						5060180390136						05060180390273
Microchip Pet Door	White	SUR101	119.99	27.2	31.7	13.5	2.2	5060180390280	70	35	29	11.8	5	05060180390402
	Brown	SUR101BR						5060180390297						05060180390433
Pet Door Mounting Adaptor	White	GMA101	15.99	40.0	45.5	1.4	0.48	5060180390303	42.5	31.5	49	10.8	20	05060180390419
	Brown	GMA101BR						5060180390310						05060180390440
Pet Door Tunnel Extender	White	TUN101	7.99	23.0	32.0	6.3	0.18	5060180390327	60.5	36.5	27	2.6	10	05060180390426
	Brown	TUN101BR						5060180390334						05060180390457
Sure Petcare RFID Collar Tag	N/A	COL001	9.99	12.0	10.5	1.4	0.02	5060180390341	49	32	41	6	300	05060180390365
Point of Sale Demonstration Kit	N/A	SKT001	N/A	41.0	28.0	17.0	4.2	5060180390679	51	30	41	13.4	3	05060180390761





[surepetcare.com](http://surepetcare.com)

Click **trade** at the top right of the page



0800 912 7114 (Mon-Fri: 8am-5pm)

For mobiles use: 01954 211664



[orders@surepetcare.com](mailto:orders@surepetcare.com)



or selected wholesalers

Contact us for more information



Free point of sale demonstration kit\*



Free promotional posters and leaflets for your store



\*Subject to agreed account type



## NEXT WORKING DAY DELIVERY

for orders placed before 2.30pm  
(two working days if placed after this time)



Help with setup and installations



Troubleshooting and problem diagnosis



Dispatch of replacement parts

Freephone: **0800 012 4511** Mon - Thurs (8am - 5pm)  
Fri (8am - 4pm)



All Sure Petcare products come with a comprehensive, no-quibble warranty. The pet doors all hold a 3-year warranty.



Also available from Sure Petcare:

## the next generation of pet feeding

see more at [surepetcare.com](http://surepetcare.com)





**SURE**  
PETCARE

An Antelliq Company

it's not just  
a pet door...

SURE FLAP

it's their **freedom**  
and **security**.

Order stock now!



[surepetcare.com](https://surepetcare.com)



0800 912 7114



[orders@surepetcare.com](mailto:orders@surepetcare.com)



Customer Care:

**0800 012 4511**

Mon - Thurs (8am - 5pm)  
Fri (8am - 4pm)

SureFlap Ltd. trading as Sure Petcare  
7 The Irwin Centre, Scotland Road,  
Dry Drayton, Cambridge, CB23 8AR